

Need Additional Evergreen Help?



**Contractor Hotline:**

**1-866-503-8566**

[www.theDealerToolbox.com](http://www.theDealerToolbox.com)

[www.EvergreenMotor.com](http://www.EvergreenMotor.com)

**Reminder: Please remember to leave this manual near the HVAC system and install the System ID Label (with completed information) near the HVAC systems wiring diagram.**



**Installation Guide**

[www.EvergreenMotor.com](http://www.EvergreenMotor.com)

[www.theDealerToolbox.com](http://www.theDealerToolbox.com)



Genteq™  
 1946 Cook Road  
 Fort Wayne, IN 46818  
 260-416-5585

[www.theDealerToolbox.com](http://www.theDealerToolbox.com)

Evergreen™ AH Installation Guide  
 © 2007 Regal Beloit Corporation

The information in this document is subject to change without notice.

## Installation Worksheet

### Replaced PSC motor data

#### Heat Pump Systems with or without Electric Strip Heat

Cooling/Heating Speed Hi\_\_\_ Med\_\_\_ Low\_\_\_ TESP\_\_\_  
 Emer. Heat Speed Hi\_\_\_ Med\_\_\_ Low\_\_\_ TESP\_\_\_ TR\_\_\_

#### Air Conditioning Systems with or without Electric Strip Heat

Cooling Speed Hi\_\_\_ Med\_\_\_ Low\_\_\_ TESP\_\_\_  
 Heating Speed Hi\_\_\_ Med\_\_\_ Low\_\_\_ TESP\_\_\_ TR\_\_\_

### Evergreen AH selection data

Check off the HVAC systems existing PSC motor horse power (Hp) and tonnage of the outdoor unit to determine the Evergreen sizing. If only one checkmark falls in each Evergreen sizing use the larger motor.

1/6, - 1/2 Hp \_\_\_ }  
 1.5 - 3 ton \_\_\_ } 1/2 Hp Evergreen AH

1/2 - 3/4 Hp \_\_\_ }  
 3.5 - 5 ton \_\_\_ } 1 Hp Evergreen AH

### Installed Evergreen AH sevt-up data

System Tonnage \_\_\_\_\_ (A/C or heat pump outdoor unit)  
 x 400 (CFM/ton)  
 = \_\_\_\_\_ Design CFM for Cooling and/or Heat Pump (Heat Mode)w

#### Heat Pump Systems with or without Electric Strip Heat

Cooling/Heating Speed Hi\_\_\_ Med\_\_\_ Hi\_\_\_ Med\_\_\_ Lo\_\_\_ Low\_\_\_  
 TESP\_\_\_ CFM\_\_\_

Emergency Heat Speed Hi\_\_\_ Med\_\_\_ Hi\_\_\_ Med\_\_\_ Lo\_\_\_ Low\_\_\_  
 TESP\_\_\_ TR\_\_\_

#### Air Conditioning Systems with or without Electric Strip Heat

Cooling Speed Hi\_\_\_ Med\_\_\_ Hi\_\_\_ Med\_\_\_ Lo\_\_\_ Low\_\_\_  
 TESP\_\_\_ CFM\_\_\_

Heating Speed Hi\_\_\_ Med\_\_\_ Hi\_\_\_ Med\_\_\_ Lo\_\_\_ Low\_\_\_  
 TESP\_\_\_ TR\_\_\_

$$CFM = \frac{BTUH}{TD \times 1.08} = \frac{\text{Volts} \times \text{Amps}}{TD \times 1.08} \times 3.4 = \frac{\text{CFM}}{\text{Speed Tap Used}}$$

BTUH = Output BTU per hour  
 CFM = Cubic Feet per Minute  
 TD = Temperature Difference, Temperature Rise & ΔT

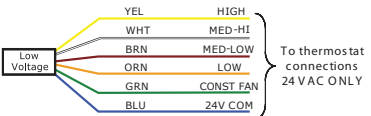
Symptom	Potential Problem	Solution
<p>The motor and/or airflow is very loud.</p> <p><b>OR</b></p> <p>The system is not maintaining the thermostat setting.</p> <p><b>OR</b></p> <p>The head pressure is tripping in the heating mode.</p> <p><b>OR</b></p> <p>The electric strips are tripping on thermal overload.</p>	<p><b>Step 1.</b> Check all of the airside components such as registers, diffusers, grilles, filters, blower wheel, and indoor coil for dirt or other restrictions. Check filter sizing, especially aftermarket filters.</p>	<p>Clean any dirt or debris on the airside components. Open and clear all registers, diffusers and grilles. Replace filters with proper size according to manufacturer specs. Aftermarket filters may need to be larger than the original specs. If this does not correct the problem go to step 2.</p>
	<p><b>Step 2.</b> Confirm that the proper speed tap has been selected for the proper demand by checking the airflow using one of the methods covered in the “Airflow Tests” section of this manual.</p>	<p>If the airflow needs to be increased or decreased, select the speed tap that produces the proper airflow for the system tonnage.</p>
		<p>If the LOW speed is too much airflow or HIGH speed is not enough airflow, check the motor sizing using the selection chart in this manual. Install the correct size motor if needed and repeat step 2. <b>(See note below first)</b> If this does not correct the problem go to Step 3.</p>
	<p><b>Note:</b> Do not oversize the motor to correct airflow problems. If the motor installed matches the motor selection chart recommendation, select the speed that produces the best possible airflow and proceed to Step 3.</p>	
<p><b>Step 3.</b> Check the system’s Total External Static Pressure (Total ESP).</p>	<p>If the total ESP is higher than the system manufacturer recommends, the problem is most likely a restricted or undersized duct system. Correct the duct issues.</p>	
	<p>If the Total ESP is lower than the system manufacturer recommends, the problem is most likely a disconnected or improper opening in the duct system. Correct the duct issues.</p>	

**Note:** Read the entire instruction manual before starting the installation.

## Table of Contents

Safety Considerations	1
Introduction	2
Quick Start Guide	3-4
Installation Guide	5
Selecting the Correct Replacement Motor	5
Mounting the Evergreen AH	6-8
Electrical Connections	9
High Voltage Power Connections	9
Low Voltage Power Connections	10-14
Final Electrical Connection Notes	14
Airflow Tests	15-16
Sequence of Operation	17
Maintenance	18
Troubleshooting Guidelines	18-19
Installation Worksheet	20
Contractor Hotline	21

## Safety Considerations

The following definitions are used as safety considerations on the Evergreen AH motor and in this manual. Please read and observe all of these safety concerns.

### SAFETY SYMBOLS



Warning indicates a hazardous situation which, if not avoided, could result in death or serious injury.



Caution indicates a hazardous situation which, if not avoided, could result in minor or moderate injury.

Installation and service of this motor should be attempted only by trained service technicians familiar with the Evergreen instructions and training manual.

This motor should be installed in accordance with accepted practices and installation instructions, and in compliance with all national and local codes.

### WARNING

The Evergreen AH is not for use in fossil fuel applications including dual fuel heat pump systems. Some safety devices would need to be added to use this design on fossil fuel applications.

### WARNING

Power should be turned off when installing, servicing, or repairing electrical components. Observe all warning notices posted on the existing equipment, Evergreen AH, and in these installation instructions.

### WARNING

The Evergreen AH is for 208-240 VAC air conditioning and heat pump applications ONLY. Connecting to the wrong voltage can be harmful to both people and property.

### CAUTION

Use of the wires provided in this kit is recommended. Should additional wires be needed, use equivalent size wire gauge and rated insulation.

### WARNING

Improper installation, adjustment, alteration, service, maintenance, or use can cause explosion, fire, electrical shock, or other conditions which may cause personal injury, death, or property damage. Consult a qualified installer, service agency, or your distributor or branch for information or assistance. The qualified installer or agency must use the supplied or recommended parts when installing or servicing this product.

## Maintenance

The Evergreen AH motor is permanently lubricated and requires no maintenance.

Any signs of water damage on the replaced PSC motor, in the HVAC system or on the Evergreen AH should be taken very seriously. Fix the water issues immediately. If there are any signs of water damage to the Evergreen AH motor it should be replaced to prevent serious injury to the occupants and the property.

All HVAC systems require annual maintenance for proper operation and to maintain maximum efficiency and capacity. See the HVAC system manufactures manuals for proper inspection and maintenance requirements. To keep the Evergreen AH motor and the airside components clean install and regularly maintain high quality properly sized filters.

## Troubleshooting Guidelines

If the troubleshooting guidelines provided here do not solve the problem or you have a problem not listed here please contact the [Evergreen Contractor Hotline 1-866-503-8566](https://www.evergreenhvac.com). If the Evergreen AH needs to be replaced, it must be a direct Evergreen AH replacement.

Symptom	Potential Problem	Solution
The motor does not run.	<b>Step 1.</b> Confirm 208-240 VAC between the two black leads of the motor. 	If there is not proper voltage at these leads, correct the problem before the motor. If the motor still does not operate after this step has been corrected, go to Step 2.
	<b>Step 2.</b> Confirm 24 VAC between any one of the speed taps (Green, Orange, Brown, White or Yellow) and the Blue lead (24 VAC common connection) 	If there is not proper voltage at one or all of these leads during proper system demand, correct the problem before the motor. The motor should operate with 24 VAC supplied to any of its speed taps, with proper 24 VAC common supplied to the blue lead of the motor. If the motor still does not operate after this has been corrected, replace the motor.

## Sequence of Operation

Line voltage (208-240 VAC) is connected to the motor at all times. This voltage alone will not operate the motor.

The motor will operate each speed when energized from the 24 VAC thermostat connections.

**Sequence of operation for LOW, MED LOW, MED HI and HIGH speeds only.** These speeds all have the same non-adjustable ramp up and off delay.

1. **24 VAC energizes a speed connection.**
2. **The motor ramps up to the selected speed.** If a higher speed connection is energized at the same time, the motor will adjust operation to that speed. If a lower speed connection is energized at the same time, the motor will ignore this speed and continue to operate at the higher speed.
3. **24 VAC is de-energized from a speed connection.** If a higher speed connection is still energized, the motor will continue to run at that speed. If a lower speed connection is still energized, the motor will adjust operation to that speed.
4. **24 VAC is de-energized from all speed connections.**
5. **The motor continues to run until the internal delay times out, and then slowly ramps down to stop.**

**Sequence of operation for CONST FAN only.** The CONST FAN speed has a special program for ultra low, quiet, constant fan operation.

1. **24 VAC energizes the CONST FAN speed only.**
2. **The motor ramps up to a very low constant fan speed.**
3. **24 VAC is de-energized from the CONST FAN speed only.**
4. **The motor slowly ramps down to stop.**

**Sequence of operation with continuous fan.**

1. **24 VAC energizes the CONST FAN speed.**
2. **The motor ramps up to a very low constant fan speed**
3. **When LOW, MED LO, MED HI, or HIGH speed is energized, the motor will operate as described above.** When the last of these speeds is de-energized and the delay has ended, the motor will slowly ramp to a stop and delay operation for five (5) minutes. If any of these speeds are again energized during the five (5) minute delay, the motor will ramp up to that speed immediately.
4. **After the five (5) minute delay has ended, the motor ramps back up to CONST FAN speed.** This is to provide time for the coil and pan to drain in the cooling operation.

## Introduction

The Evergreen AH is an ECM (Electronically Commutated Motor) designed to replace an existing PSC (Permanent Split Capacitor) induction, indoor blower motor. It is constructed with over 20 years of ECM technology and reliability improvements.

### WARNING

The Evergreen AH is not for use in fossil fuel applications including dual fuel heat pump systems. Some safety devices would need to be added to use this design on fossil fuel applications.

**This motor is intended for use on the following types of HVAC systems ONLY:**

- Air Conditioning or Heat Pump Package Systems with or without Electric Strip Heat
- Air Handlers with or without Electric Strip Heat connected to Air Conditioning or Heat Pump Systems
- Single or Two Stage Systems or Hot Water Coil Systems
- Direct Drive (non-belted) applications

**DO NOT** use this motor to replace an existing ECM other than a direct replacement of an Evergreen AH.

This installation/service manual enables a qualified technician to install, service, repair and maintain the Evergreen AH motor. **This manual is to be left near the HVAC system for future reference.**

Page 20 contains an Installation Worksheet to write down all the critical information for the selection, installation and airflow testing.

The following parts for installation and wiring connections included are:

- 8 fork terminals (#8)
- 6 cable ties (5")
- 5 wire nuts (yellow)
- Optional Y-adapter

**The “Quick Start Guide” on pp. 3-4 is an abbreviated version of the “Installation Guide”. It is intended for highly qualified technicians who are very familiar with wiring diagrams, proper motor installation practices and airflow diagnostics.**

**The “Installation Guide” on pp. 5-14 provides a complete step by step process for installing the motor, connecting the wires, and confirming the airflow for each stage of operation.**

# Quick Start Guide\*

\*Please read the Safety Considerations on page 1 and the Introduction on page 2 before using the Quick Start Guide.

- Before removing the existing motor**, check off the existing speed selections, in each mode of operation, in the spaces below. If the motor is operational, also record the Total External Static Pressure (TESP) and/or the Temperature Rise (TR) in each mode of operation. This information will help select the new motor speeds.

### Heat Pump Systems with or without Electric Strip Heat

Cooling/Heating Speed Hi \_\_\_ Med \_\_\_ Low \_\_\_ TESP \_\_\_\_\_  
 Emer. Heat Speed Hi \_\_\_ Med \_\_\_ Low \_\_\_ TESP \_\_\_\_\_ TR \_\_\_\_\_

### Air Conditioning Systems with or without Electric Strip Heat

Cooling Speed Hi \_\_\_ Med \_\_\_ Low \_\_\_ TESP \_\_\_\_\_  
 Heating Speed Hi \_\_\_ Med \_\_\_ Low \_\_\_ TESP \_\_\_\_\_ TR \_\_\_\_\_

- Select the proper Evergreen motor.**

Confirm rotation of the motor to be replaced matches Evergreen AH. The standard direction of the new motor is counter clockwise (CCW) when viewed from the lead end. If clockwise (CW) is desired, contact your dealer. The shaft size is 1/2" wide by 5" long.

Check off the HVAC systems existing PSC motor horse power (Hp) and the tonnage of the outdoor unit to determine the Evergreen AH sizing. If only one checkmark falls in each Evergreen AH sizing, use the larger motor.

1/6 - 1/2 Hp	___	}	1/2 Hp Evergreen AH
1.5 - 3 ton	___		
1/2 - 3/4 Hp	___	}	1 Hp Evergreen AH
3.5 - 5 ton	___		

- Install the Evergreen AH motor in existing or new motor mount. The motor mount must be belly band style. (See pp. 6-8 for more details)**

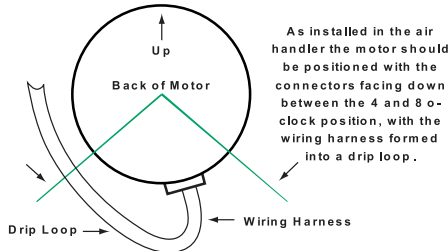
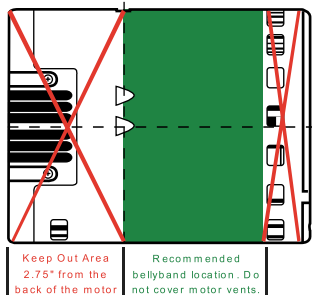

# Calculating CFM - Temperature Rise Method (continued)

- Operate only the electric strips and the indoor blower on the speed of choice for this measurement.**

- Measure the voltage and total amperage of the electric strip(s) and the indoor fan.** Do this at the main power supply in the HVAC system. If there are multiple circuits for multiple sets of strips, add the amperage from all the circuits together.

- Use the formula BTUH = Volts x Amps x 3.4 with your measured values to calculate the system's BTUH.**

- Calculate the heat rise of the system.** Measure the supply and return air temperatures and subtract to get the Temperature Difference (TD) of the system. These readings should be taken as close to the HVAC system as possible but out of the line of sight of the electric strip(s). Traverse the measurement area taking 5 or more readings for maximum accuracy.

- Using the numbers that you have calculated for the system, plug them into the formula below to calculate the system's CFM.**

$$CFM = \frac{BTUH}{TD \times 1.08} = \frac{\text{Volts} \times \text{Amps} \times 3.4}{TD \times 1.08} = \frac{\text{Speed Tap Used}}{\text{Speed Tap Used}} \text{ CFM}$$

BTUH = Output BTU per hour  
 CFM = Cubic Feet per Minute  
 TD = Temperature Difference, Temperature Rise & ΔT

- Verify that the system's CFM is about 400 CFM/ton (or your regional recommendations).** If not, select another motor speed and repeat the process again. This process is very important and must not be overlooked. Without proper CFM, the system will not heat and/or cool to its full capacity.

System Tonnage \_\_\_\_\_ (A/C or heat pump outdoor unit)  
 x 400 (CFM/ton)  
 = \_\_\_\_\_ Design CFM for Cooling and/or Heat Pump (Heat Mode)

## Airflow Tests

After installing the Evergreen AH motor it is important to verify that the speed tap(s) selected will provide the proper airflow in all modes of operation for maximum performance, comfort, capacity and safe operation.

Before checking the airflow, all filters should be cleaned or replaced. All grilles and registers should also be clear and open.

### Minimum Set-up Requirement

Confirm airflow is matched to original PSC motor operation:

- Compare temperature rise and/or total external static pressure to pre-installation measurements.
- Adjust the speed selections until these parameters match.

### Recommended Set-up

Confirm airflow is matched to the system's performance requirements:

- Measure airflow with industry accepted instruments
- Measure airflow with the Temperature Rise Method (see below)
- Adjust the speed selections to achieve the design CFM (Cubic Feet per Minute) per ton of cooling.

Note: Cooling only systems will require airflow to be measured with an industry accepted air measuring device.

## Calculating CFM - Temperature Rise Method

This method requires the operation of the electric strips and the indoor blower motor only by setting the thermostat to call for heat (W) on air conditioning systems with electric strip heat or emergency heat (W2) on heat pump systems with electric strips.

### Multiple speed systems:

To verify the CFM (Cubic Feet per Minute) for cooling operation, temporarily move the cooling speed originally connected to (Y), to (W) or (W2) respective to the system being tested. When finished, reconnect this speed, or the speed found to achieve the proper airflow, to (Y) and reconnect the speed selected for (W) or (W2) respective to the system.

4. **Connect the high voltage harness.** Using the schematic below, connect to a constant line voltage source, after the system door switch if applicable. If the system has multiple line voltage circuit, connect to the same circuit that powers the control board or fan relays for the original motor. **(See p. 9 for more details)**

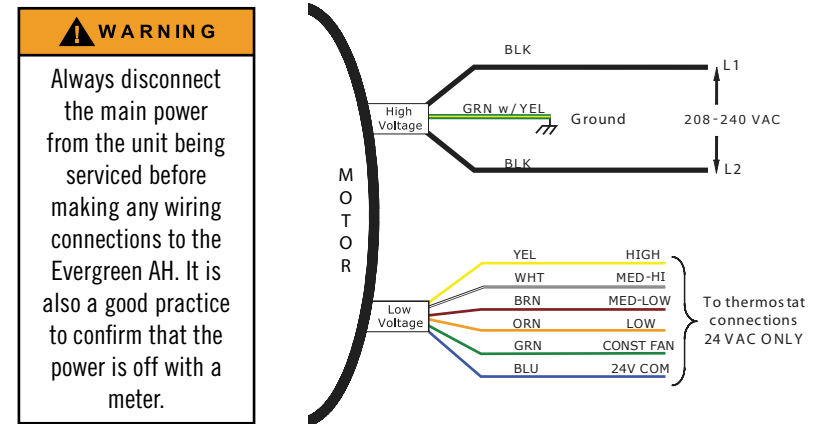

5. **Connect the low voltage harness.** Using the schematic above, connect the thermostat wires to the desired speeds. **(See pp. 10-14 for more details)**
  - (C) connects to transformer common
  - (Y) for heating and/or cooling speed
  - (W) for heat or (W2) for emergency heat speed
  - (G) connects to the FAN LOW speed
  - Optional - Use the supplied Y–adapter if one speed is to be used for heating and cooling. See schematic below.

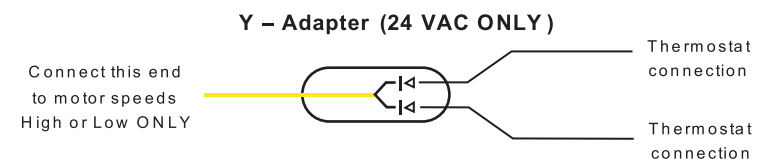

6. **Install the System ID Label on the HVAC system near the existing wiring diagram and enter the Evergreen AH data.**
7. **Confirm system operation and proper airflow in all modes of operation.** **(See pp. 15-16 for more details)** Complete the Installation Worksheet on page 20.

## Installation Guide - Selecting the Correct Replacement Motor

The number of speeds used by the PSC motor is not important. The Evergreen AH motor has enough speeds to accommodate heating, cooling and continuous fan operations.

**Note:** None of the original PSC motors wiring or connection points will be reused to install the Evergreen AH.

**Before removing the existing motor**, check off the existing speed selections in each mode of operation, in the spaces below. If the motor is operational, also record the Total External Static Pressure (TESP) and/or the Temperature Rise (TR) in each mode of operation. This information will help select the new motor speeds.

### Heat Pump Systems with or without Electric Strip Heat

Cooling/Heating Speed Hi \_\_\_ Med \_\_\_ Low \_\_\_ TESP \_\_\_\_\_  
 Emer. Heat Speed Hi \_\_\_ Med \_\_\_ Low \_\_\_ TESP \_\_\_\_\_ TR \_\_\_\_\_

### Air Conditioning Systems with or without Electric Strip Heat

Cooling Speed Hi \_\_\_ Med \_\_\_ Low \_\_\_ TESP \_\_\_\_\_  
 Heating Speed Hi \_\_\_ Med \_\_\_ Low \_\_\_ TESP \_\_\_\_\_ TR \_\_\_\_\_

### Select the proper Evergreen motor.

Confirm the rotation of the motor to be replaced matches Evergreen AH. The standard direction of the Evergreen AH motor is counter clock-wise (CCW) when viewed from lead end. If clock-wise (CW) is desired, contact your dealer. The shaft size is 1/2" wide by 5" long.

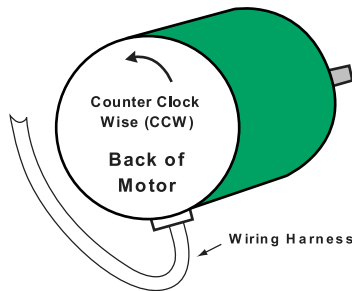

Check off the HVAC systems existing PSC motor horse power (Hp) and the tonnage of the outdoor unit to determine the Evergreen AH sizing. If only one checkmark falls in each Evergreen AH sizing, use the larger motor.

1/6 - 1/2 Hp	___	}	1/2 Hp Evergreen AH
1.5 - 3 ton	___		
1/2 - 3/4 Hp	___	}	1 Hp Evergreen AH
3.5 - 5 ton	___		

## Electrical Connections - Low Voltage Power Connections (continued) Multiple Speed Systems

### Heat Pump Systems with or without Electric Strip Heat

**Step 1:** Connect the speed to be used for cooling and heating to the (Y) terminal.

**Step 2:** Connect the speed to be used for emergency heat to the (W2) terminal.

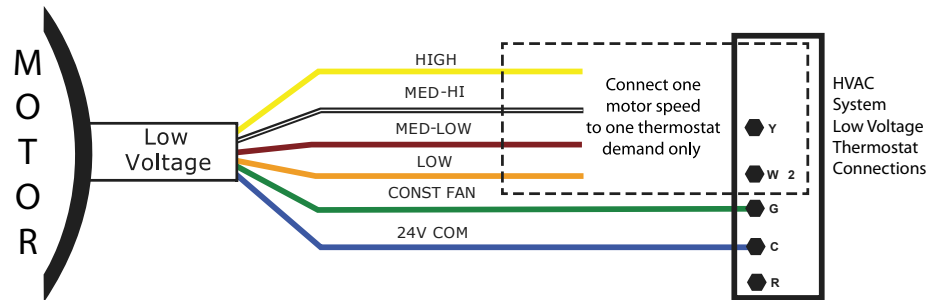

Install the System ID Label on the HVAC system near the existing wiring diagram and enter the Evergreen AH data.

Follow the instructions in the next section, "Final Electrical Connection Notes".

### Final Electrical Connection Notes

When finished connecting all of the Evergreen AH wires to the system, use the provided cable ties to clean up the harness, create the recommended drip loop, and assure it will not interfere with the blower wheel or other system wiring.

It is ok to leave extra wire, especially the unused speeds. Tie them to the harness for future use if needed. Even though the extra speed wires will have no voltage or current on them, it is a good practice to wire nut and tape these unused leads.

**Verify that the system operates correctly by following the instructions in the next section on "Airflow Tests."**



## Electrical Connections - Low Voltage Power Connections (continued)

### Multiple Speed Systems

This section is for HVAC systems that use individual speeds for each mode of operation. Refer to the speeds the original PSC motor used for this section. Use the same speeds on the Evergreen AH as a point of reference.

Most HVAC systems use the same terminal designations for their thermostat demands, however there are variations. If the terminal designations in the HVAC system being connected to are different than the ones used in our diagrams, match them up to the operation of our generic listing below.

Air Conditioning Systems with or without Electric Strip Heat

Y – Call for cooling

W – Call for heating (electric strips)

Heat Pump Systems with or without Electric Strip Heat

Y – Call for heating and cooling (operates the outdoor unit contactor)

W2 – Call for Emergency Heat

Choose the motor speed for each mode of operation and connect according to the following diagrams.

### Air Conditioning Systems with or without Electric Strip Heat

Step 1: Connect the speed to be used for cooling to the (Y) terminal.

Step 2: Connect the speed to be used for heating to the (W) terminal.

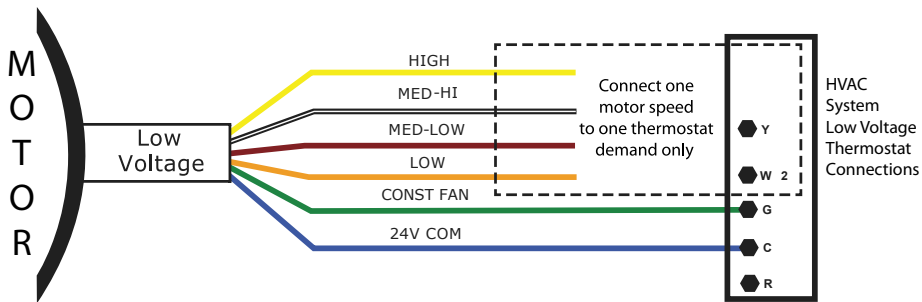

## Installation Guide - Mounting the Evergreen AH

### WARNING

Power should be turned off when installing, servicing, or repairing electrical components. It is also a good practice to confirm that the power is off with a meter.

Remove the blower section from the HVAC system. Remove the existing PSC motor from the blower section. Properly dispose of the motor and the run capacitor. The Evergreen AH motor does not require a run capacitor.

The frame size of the Evergreen AH motor is NEMA 48 frame. This is the most common frame size for indoor blower motors. If the original motor has the same frame size, the original mounting bracket should work on the Evergreen AH. **The Evergreen AH requires a belly band style mounting bracket. Torsion flex and any mount that bolts directly to the motor is not recommended.**

If the original mounting bracket attaches to the bearing assembly, it will need to be replaced. If the mounting bracket must be replaced, selecting one with the same mounting pattern on the blower housing will save drilling new holes in the blower section.

The belly band must fit the new motor properly. It should be tight enough to prevent the motor from shifting on start-up and not cover any vents. On ECM motors the belly band must not be placed over the motor control section.

**Note:** when attaching the bellyband mount, make sure it is not located in the “Keep Out Area” area.

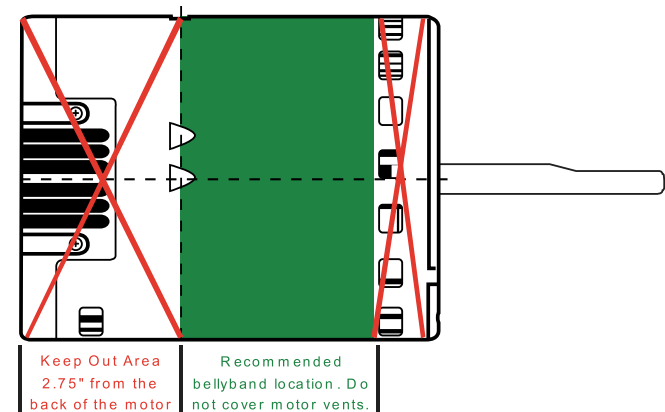

## Installation Guide - Mounting the Evergreen AH (continued)

The properly installed bellyband is between the top vents and the dimples at the bottom of the stator stack (2.75" from the back or bottom of the motor). The location of the bellyband securing bolt on the motor is not critical.

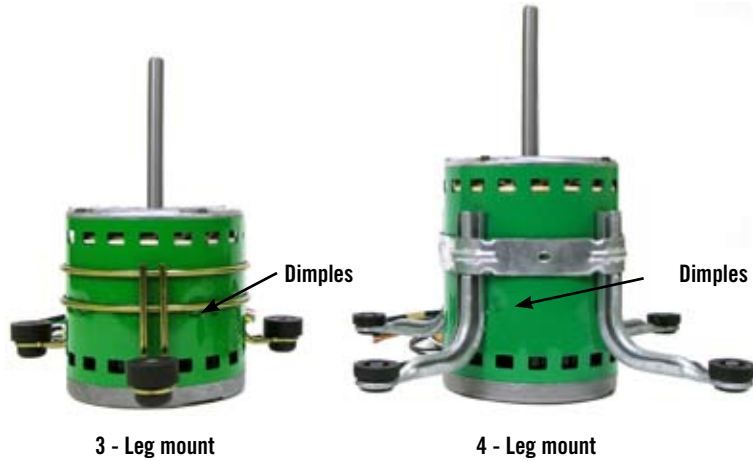

The above pictures show examples of the recommended belly band styles. The 1HP may use a 3 or 4 leg mount.

Below are examples of motor mounting brackets that are **NOT** recommended on the Evergreen AH.

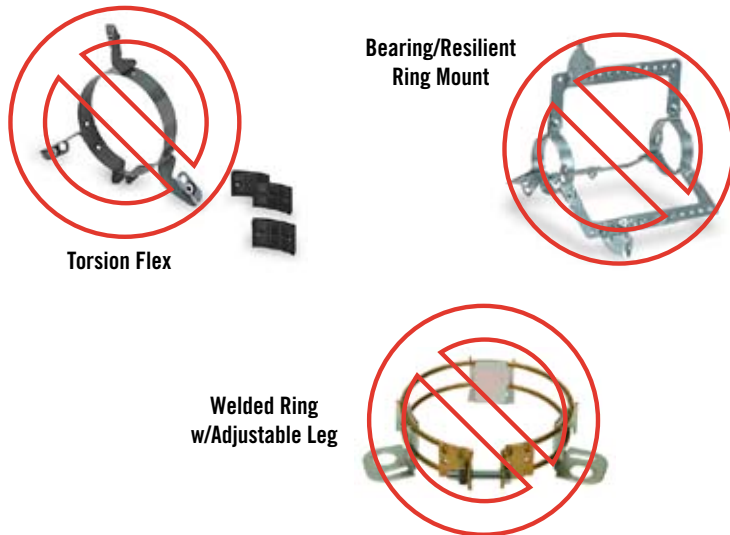

## Electrical Connections - Low Voltage Power Connections (continued) Single Speed Systems

### Air Conditioning Systems with or without Electric Strip Heat

**Step 1:** Wire the two input lines from the 24 VAC Y-adapter to the (Y) and (W) thermostat connections in the HVAC system.

**Step 2:** Connect the output lead from the adapter to desired motor speed line.

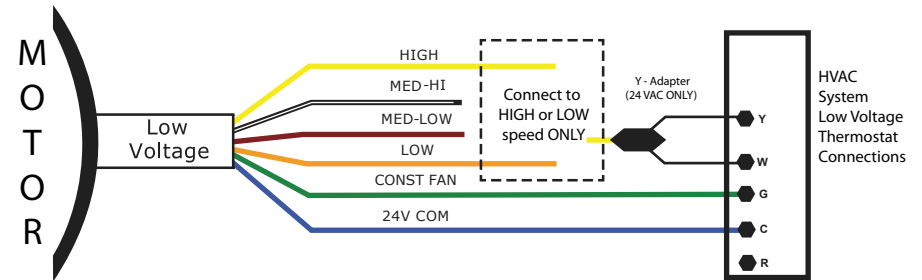

### Heat Pump Systems with or without Electric Strip Heat

**Step 1:** Wire the two input lines from the 24 VAC Y-adapter to the (Y) and (W2) thermostat connections in the HVAC system.

**Step 2:** Connect the output lead from the adapter to desired motor speed line.

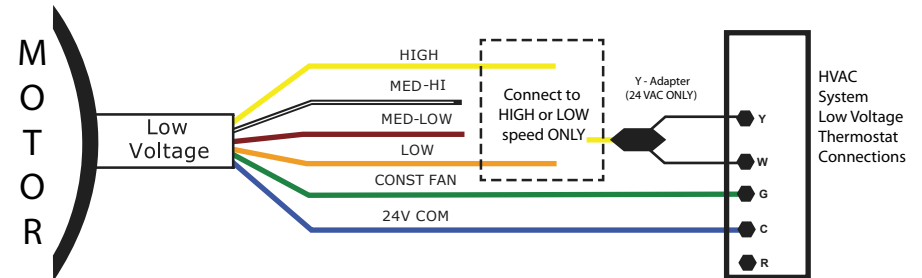

Install the System ID Label on the HVAC system near the existing wiring diagram and enter the Evergreen AH data.

Go to page 14 and follow the "Final Electrical Connection Notes".

## Electrical Connections - Low Voltage Power Connections (continued)

### Single Speed Systems

**This section is for HVAC systems that use one speed for all modes of operation.**

For many systems, the same speed is used for heating, cooling, and emergency heat operation (if applicable).

Refer to the speed the original PSC motor used for this section. Use the same speed on the Evergreen AH as a point of reference.

To allow the motor to operate at the same speed from two different thermostat demands, the special **24 VAC Y-adapter** included in the box must be used. **Do not attempt to use any other method to wire two thermostat lines to the same speed.** The Y-adapter is specially designed for this application to prevent voltage feedback, and the operation of multiple demands at the same time.

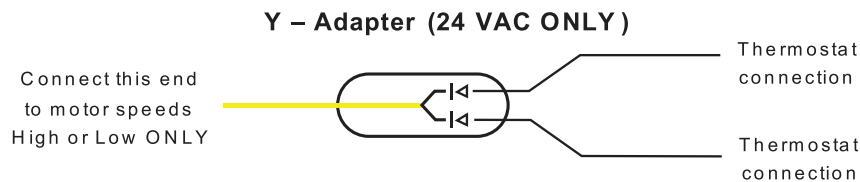

**Only the High and Low speeds can be used with the Y adapter.** If Medium Low or Med HI is found to be the best airflow selection for cooling, another speed should be selected for the heating or emergency heat operation (if applicable) and the Y-adapter should not be used. Typically the next lower speed will work in this application for either demand. See pp. 13-14 for wiring multiple speeds.

Most HVAC systems use the same terminal designations for their thermostat demands. However there are variations. If the terminal designations in the HVAC system being connected to are different than the ones used in our diagrams, match them up to the operation of our generic listing below.

Air Conditioning Systems with or without Electric Strip Heat

Y – Call for cooling

W – Call for heating (electric strips)

Heat Pump Systems with or without Electric Strip Heat

Y – Call for heating and cooling (operates the outdoor unit contactor)

W2 – Call for Emergency Heat

## Mounting the Evergreen AH (continued)

If a new motor mount is required and the legs do not line up with the original holes in the blower housing, it is required to use a bolt with either a lock washer and nut or a locking nut through the newly drilled hole(s). Self tapping or sheet metal screws are not a sufficient long term installation when a new hole is drilled through the thin wall of the blower housing.



When positioning the legs of the bellyband on the motor, make sure that once the motor is mounted into the blower section, the wires come out toward the bottom of the motor as installed in the air handler. This will insure that a proper drip loop can be made with the signal and power lines.

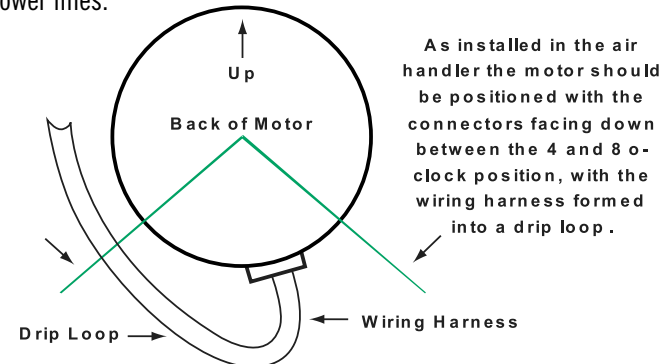

The blower wheel should be centered in the blower housing. The wheel should also not be resting up against the motor bearing housing. If this is not possible while centering the wheel the motor should be adjusted in the bellyband. If the blower wheel is dirty, it should be cleaned.



The blower wheel hub locking bolt should be secured to the motor shaft on the flat portion of the shaft, after the wheel has been centered in the blower housing.

Reinstall the blower section in the HVAC system and proceed to the next page to make the electrical connections.

## Electrical Connections - High Voltage Power Connections

The Evergreen AH is connected to line (High) voltage power at ALL TIMES. Motor operation is controlled by low voltage lines.

Do not connect the high voltage leads of the Evergreen AH motor to any relays or switched circuit board terminals.

If a door switch is present, wire after the switch so power will be disconnected when the door is removed for service or maintenance.

If the HVAC system has multiple line voltage circuits (typically on systems with multiple heat strips), connect the Evergreen AH to the same circuit that powers the control board or fan relay for the original motor.

**Step 1: Cut the high (Line) voltage harness to the length needed to reach the desired line voltage connection point.**

**Step 2: Strip the insulation back to connect bare wires or install the supplied fork terminals. Wire nuts are also supplied if needed.**

**⚠ WARNING**

Always disconnect the main power from the unit being serviced before making any wiring connections to the Evergreen AH. It is also a good practice to confirm that the power is off with a meter.

**Step 3: Wire the two black power leads from the Evergreen AH to L1 and L2 of the system.**

**Step 4: Wire the Green w/Yellow strip ground wire to system ground.**

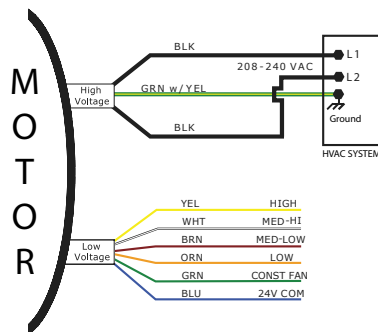

## Electrical Connections - Low Voltage Power Connections

Do not connect the low voltage (speed) communication connections from the Evergreen AH motor where the PSC motor was wired. Any voltage above 33 VAC connected to these terminals will cause damage to the motor.

The Evergreen AH is unique in how it operates. Unlike a PSC motor, the Evergreen AH motor operation (speed) is selected by the low voltage communication inputs powered directly from the HVAC system thermostat lines.

Do not remove the existing thermostat lines connected to the HVAC system from the thermostat. The Evergreen AH is wired in parallel to these connections. The lines from the thermostat still need to be connected to the HVAC system for correct operation.

**Note:** There can be more than one speed tap powered on the Evergreen motor at the same time. Unlike PSC motors, the Evergreen will operate the highest speed tap that has low voltage communication.

**Step 1: Cut the low voltage harness to the length needed to reach the HVAC system thermostat connections.**

**Step 2: Strip the insulation back to connect bare wire or install the supplied fork terminals to the appropriate speed selections determined below. Wire nuts are also supplied if needed.**

**Step 3: Connect the 24 VAC common (C) side of the transformer from the HVAC system to the motor 24V COM wire.** Make sure that this line is not connected to the side of the transformer connected to the thermostat (R). If it is connected to the (R) high side of the transformer, the motor will not operate.

**Step 4: Connect for constant fan.** One of the unique features of the Evergreen AH is the energy saving constant fan speed. To wire the Evergreen AH for constant fan operation, wire the CONST FAN speed line to the HVAC system (G) thermostat connection.

